

Survey and Installation

All openings must feature a lintel, no load is to be transferred to any part of the doorset.

Doorset is to be securely fixed to the structure using suitable fixings. Minimum of two per perimeter member, maximum 600mm centres, corner fixings to be 150 to 250mm from external corner.

Perimeter of doorset to be continuously sealed using low modulus, high elasticity sealant.

Debris to be removed from all drainage channels, track and rolling mechanisms.

Installation to comply with all elements of BS8213-4 Code of practice for the survey and installation of windows and external doorsets.

Find your local Liniar stockist at:



t.01332 883 900
 sales@liniar.co.uk
 www.liniar.co.uk
 Liniar Windows, Flamstead House,
 Denby Hall Business Park,
 Denby, Derbyshire, DE5 8JX



Glazing / Toe and Heeling

All glazing must fall in line with the requirements of BS6262 and any recommendations of the glass manufacturers.

The correct use of glazing packers is critical to allow bi-fold doors to function correctly. The diagram to the right shows both a left and right opening door and the position of the glazing packers. The dashed lines indicate the position of the load bearing packers for all of the typical assemblies.

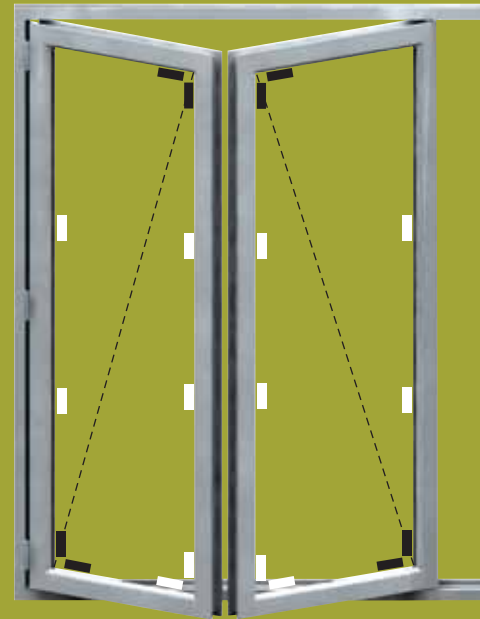
It is essential that the glass stays in position and we therefore recommend that where necessary, the packers are siliconed into position. Ensure that all packers do not obstruct any drainage holes.



-  Load bearing packers to keep door square and level
-  Packing to prevent glass movement and provide rigidity to the door

Operating and maintenance

Operation

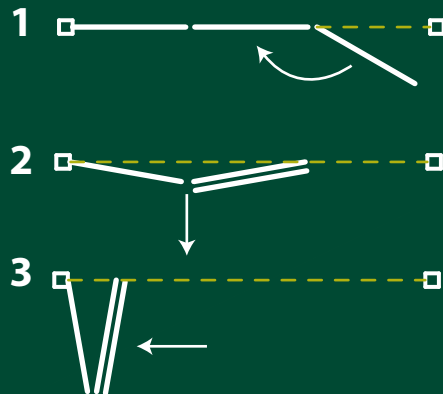

Maintenance

- Roller mechanisms carrying the door panels are fitted with sealed stainless steel bearings and require no lubrication.
- Ensure top and bottom tracks are kept free from debris or obstacles which may impair the function of the product.
- Door locking mechanisms to be cleaned and any moving parts to be lubricated with a light machine oil at least once a year and more frequently where appropriate.
- For u-PVC parts clean regularly with soap and water.



DOORS
 Installation and
 operation guide

Liniar Bi-Fold Plus Installation Example: 5-3-2



Meeting Stile Fixing

Meeting Stile fixed to door after single roller adjustment. To be fixed from either inside or outside.

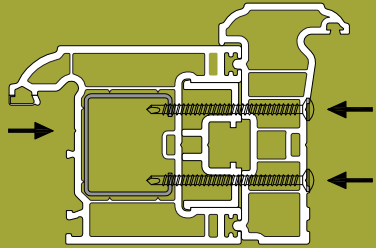

Hinge Adjustment

Add/Remove hinge packers to adjust each hinge independently.

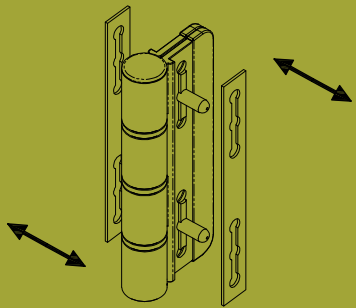

Removable pins for transportation and ease of installation
2 Packers = Nominal 8mm Gap
Total hinge adjustment: ± 2 mm

Toe and Heel

Each door to be 'toe and heeled' to suit constant nominal door gaps of 8mm. (see reverse)

Roller Adjustment

Remove cap for allen key adjustment.

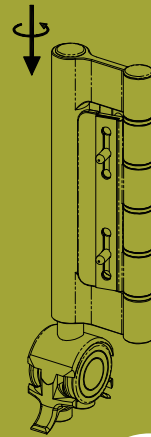
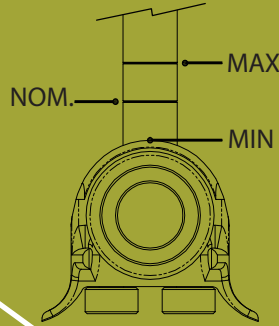

Double Roller

Adjust both top and bottom rollers to minimum point for sash assembly in frame.

Once assembled in frame adjust back to nominal to suit 8mm door gap.

Adjust top roller to suit desired compression.



Frame Fixings

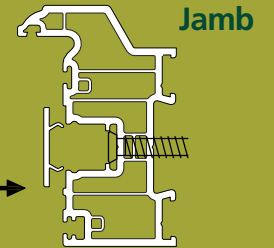

Fix through recess at 600mm centres. Clip trim/track in after fixing.

Head/Threshold

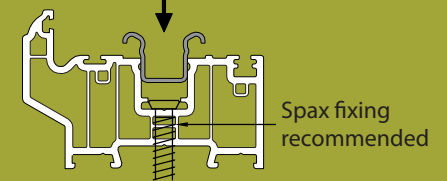

Spax fixing recommended

Roller Adjustment

Remove cap for allen key adjustment.

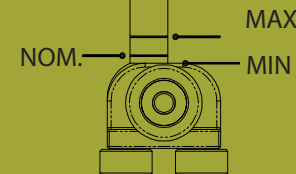

General Installation

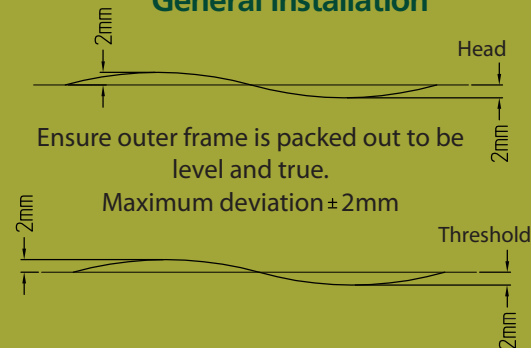

Ensure outer frame is packed out to be level and true.

Maximum deviation ± 2 mm